

EN User manual

2

Built in double oven

# USER MANUAL

ZOD370

**ZANUSSI**  
Get Living!

# Contents

Safety information	2	What to do if...	17
Product description	3	Installation	18
Before first use	4	Disposal	22
Operation	5	GREAT BRITAIN & IRELAND - Guarantee/Customer Service	22
Use, tables and tips	7	www.electrolux.com	23
Care and cleaning	13		

Subject to change without notice

## Safety information

These warnings are provided in the interests of your safety. Ensure that you understand them all before installing or using the appliance.

Your safety is of paramount importance. If you are unsure about any of the meanings of these warnings please contact customer care.

### Installation

- The appliance must be installed according to the instructions supplied.
- The installation work must be undertaken by a qualified electrician or competent person.
- The appliance should be serviced by an authorised Service Engineer and only genuine approved spare parts should be used.
- The appliance must be installed in an adequately ventilated room.
- It is imperative that the appliance is left in the base to protect both the appliance and the floor.
- This appliance is heavy and care must be taken when moving it. Always wear safety gloves.
- Do not attempt to lift or move this appliance by the handles.
- All packaging, both inside and outside the appliance must be removed before the appliance is used.
- It is dangerous to alter the specifications or modify the appliance in any way.

### Child safety

- Do not allow children to play with any part of the packaging.
- Do not allow children to sit or climb on the drop down doors.
- This appliance is not intended for use by children and other persons whose physical, sensory or mental capabilities or lack of experience and knowledge prevents

them from using the appliance safely without supervision or instruction by a responsible person to ensure that they can use the appliance safely.

- Children should be supervised to ensure that they do not play with the appliance.

 **Caution!** Accessible parts may be hot. Young children should be kept away.

### During use

 **Warning!** Never leave the appliance unattended when the oven door is open.

- This appliance is not intended to be operated by means of an external timer or separate remote control system.
- This appliance has been designed for domestic use to cook edible foodstuffs only and must not be used for any other purposes.
- Take great care when heating fats and oils as they will ignite if they become too hot.
- Never place plastic or any other material that may melt in or on the oven.
- Always support the grill pan when it is in the withdrawn or partially withdrawn position.
- Always use oven gloves to remove and place food in the oven.
- During use the appliance becomes hot. Care should be taken to avoid touching the heating elements inside the oven.
- Ensure that all vents are not obstructed to ensure ventilation of the oven cavity.
- Never line any part of the appliance with foil.
- Always stand back from the appliance when opening the oven door to allow any build up of steam or heat to release.

- Stand clear when opening the drop down doors. Support the doors using the handles until fully open.
- Do not place sealed cans or aerosols inside the oven. They may explode if they are heated.
- Ensure that all control knobs are in the OFF position when not in use.
- Do not stand on the appliance or on the open oven doors.
- Do not hang towels, dishcloths or clothes from the appliance or its handles.
- Do not use this appliance if it is in contact with water. Never operate it with wet hands.

### Cleaning and maintenance

**Warning!** For hygiene and safety reasons this appliance should be kept clean at all times. A build-

up of fat or other foodstuff could result in a fire especially in the grill pan.

- Do not leave cookware containing foodstuffs, e.g. fat or oil in the appliance in case it is inadvertently switched on.
- Always allow the appliance to cool before switching off at the wall prior to carrying out any cleaning/maintenance work.
- Only clean this appliance in accordance with the instructions given in this book.
- Never use steam or high pressure steam cleaners to clean the appliance.

## Product description

### General overview

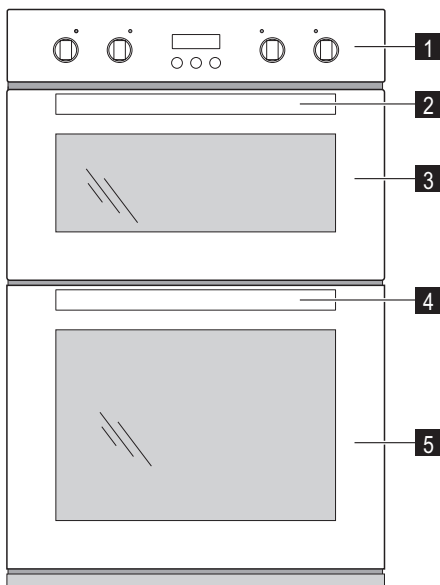

- 1 Control panel
- 2 Top oven handle
- 3 Top oven
- 4 Main oven handle
- 5 Main oven

## Control Panel Overview

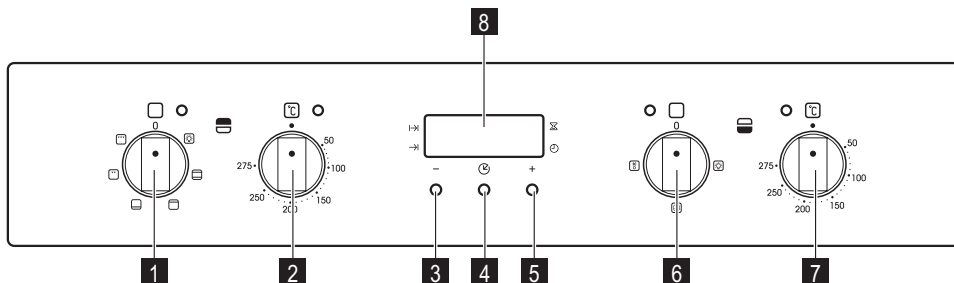

- 1 Top oven function knob
- 2 Top oven temperature knob
- 3 Decrease button
- 4 Mode button
- 5 Increase button
- 6 Main oven function knob
- 7 Main oven temperature knob
- 8 Display

### Oven accessories

#### 3 oven shelves

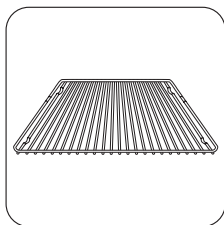

#### Oven grill shelf

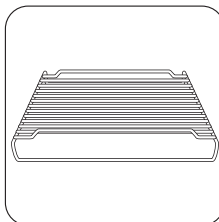

#### Anti stick meat/Drip pan

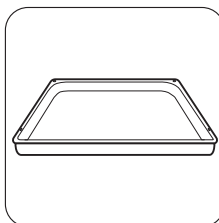

## Before first use

### Rating plate

This is situated on the front frame of the appliance and can be seen upon opening the door. Alternatively the rating plate may also be found on the back or top of some models (where applicable).

The appliance must be protected by a suitably rated fuse or circuit breaker.

The rating of the appliance is given on the rating plate.

**Warning!** Do not remove the rating plate from the appliance as this may invalidate the guarantee.

### Preparing to use your appliance

Wipe over the base of the oven(s) with a soft cloth using hot soapy water. Wash the furniture before use.

We suggest that you run the oven(s) and grill for 10 – 15 minutes at maximum temperature, to burn off any residue from their surfaces. Accessible parts may become hotter than in normal use. Children should be kept away. During this period an odor may be emitted, it is therefore advisable to open a window for ventilation.

## The cooling fan

The cooling fan comes on immediately the top oven or grill is switched on. It may run on after the ovens are switched off until the appliance has cooled. During the cooling down period the cooling fan may switch on and off.

**Warning!** Always allow the cooling fan to cool the appliance down before switching off the electrical supply to carry out cleaning or maintenance.

## Control panel indicator neon(s)

The indicator neon will operate when the oven(s) is switched on. The indicator neon will glow. It may turn on and off during use to show that the setting is being maintained. If the neon does not operate as the instructions indicate the controls have been incorrectly set. Return all controls to zero and reset following the instructions for the required setting.

## Condensation and steam

When food is heated it produces steam similar to a boiling kettle. The vents allow some of this steam to escape. However, always stand back from the appliance when opening the door(s) to allow any build up of steam or heat to release.

If the steam comes into contact with a cool surface on the outside of the appliance, e.g. a trim, it will condense and produce water droplets. This is quite normal and is not caused by a fault on the appliance.

To prevent discoloration, regularly wipe away condensation and foodstuff from surfaces.

For your safety wall coverings at the rear of the appliance should be securely fixed to the wall.

## Cookware

Baking trays, dishes etc., should not be placed directly against the grid covering the fan at the back of the oven. Do not use baking trays larger than 30cm x 35cm (12" x 14") as they will restrict the circulation of heat and may affect performance.

## Operation

### The top oven

The top oven is the smaller of the two ovens. It is heated by elements in the top and bottom of the oven. It is designed for cooking smaller quantities of food. It gives especially good results if used to cook fruitcakes, sweet and savoury flans or quiche.

## Setting the Time

**i** The oven only operates when the time has been set.

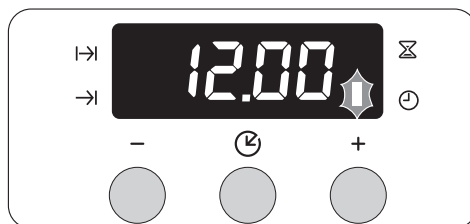

1. When the appliance is connected to the electrical supply or when there has been a power cut, Time ⌚ flashes automatically.
2. Using the + or - button, set the current time.
3. After approx. 5 seconds, the clock stops flashing and the clock displays the time of day set.  
The appliance is now ready to use.

## Initial Cleaning

Before using the oven for the first time you should clean it thoroughly.

**Warning!** Do not use any caustic, abrasive cleaners! The surface could be damaged.

**i** To clean metal fronts use commercially available cleaning agents.

1. Turn the oven function switch to oven lighting .
2. Remove all accessories and the shelf support rails and wash them with warm water and washing up liquid.
3. Then wash out the oven with warm water and washing-up liquid, and dry.
4. Wipe the front of the appliance with a damp cloth.

The top oven is ideal for use as a warming compartment. It can be used to warm dishes and keep food hot. Use the lowest setting on the top oven temperature control.

**Warning!** Do not place cookware and cooking pots with rough bases e.g. cast iron on the oven door as damage to the glass may occur.

**Important! Always grill with the door closed.**

### Switching the Oven On and Off

1. Turn the oven functions dial to the desired function.
2. Turn the temperature selector to the desired temperature.
3. To turn the oven off, turn the oven functions dial and the temperature selector to the Off position.







 The power indicator is lit as long as the oven is in operation.

 The temperature pilot light is lit as long as the oven is heating up.



 The fan switches on automatically in order to keep the appliance's surfaces cool. When the oven is switched off, the fan continues to run to cool the appliance down, then switches itself off automatically.

## Oven Functions





### Top Oven

Oven function	Application
 Light	Using this function you can light up the oven interior, e.g. for cleaning.
 Conventional Cooking	Heat from the top and bottom elements provide traditional cooking. Ideal for cooking traditional meals, breads and cakes. For the best results cook on one level.
 Top Heat	This function uses a heat from the top element, ideal for browning lasagne or shepherds pie.
 Bottom Heat	This function uses the base element to give single level cooking. Suitable for reheating pies and pastries as it keeps the pastry base crisp.
 Single Circuit Grill	For grilling food placed in the middle of the grill and for toasting.
 Dual Circuit Grill	For grilling food in large quantities and for toasting.





### Bottom Oven

Oven function	Application
 Light	Using this function you can light up the oven interior, e.g. for cleaning.
 Thermaflow®	The fan function is particularly suitable for cooking larger quantities of food. Set the oven temperatures 20-40 °C lower than when using Conventional.
 Defrost	This function defrosts most foods faster than more conventional methods. It is particularly suitable for delicate frozen foods, which are to be served cold, e.g. gateaux, cheesecakes, etc.





## Clock Functions

- Countdown  - See appropriate chapter on setup. A signal sounds after the time has elapsed. This function does not affect the functioning of the oven.
- Cook time  - is used to set the desired period of cooking time.
- End time  - when set the appliance is turned off at desired time.
- Time  - shows the current time.

### How to use the clock functions

- After a function has been selected, the corresponding function indicator flashes for about 5 seconds. During this period, the desired times can be set using the increase  or decrease  button.
- When the desired time has been set, the function indicator continues to flash for approx. 5 seconds. After that the function indicator is then lit. The set time begins to run.
- Press any of the buttons to stop the audible signal.
- The desired oven function and temperature can be selected before or after the clock functions Cook time  and End time  are set.
- When the cooking process is completed, turn the oven function dial and the temperature selector back to the OFF position.

## Countdown

1. Press the Mode  button repeatedly until the function indicator Countdown  flashes.
2. Using the increase  or decrease  button set the desired Countdown (max. 2 hours 30 minutes).
3. After approx. 5 seconds the display shows the time remaining. The function indicator Countdown  lights up.

## Use, tables and tips

---





### Baking

#### Oven levels





- Baking with Conventional Cooking is only possible on one level.
- When baking with Fan Cooking one to two baking trays can be put into the bottom oven at the same time:

4. When the time has elapsed, the function indicator flashes and an audible signal sounds for 2 minutes. The signal can be stopped by pressing any button.

## Cook time

1. Press the Mode  button repeatedly until the function indicator Cook time  flashes.
2. Using the increase  or decrease  button set the desired cooking time.  
After approx. 5 seconds the display returns to showing the current time. The function indicator Cook time  lights up.  
When the time has elapsed, the function indicator flashes, an audible signal sounds for 2 minutes and the oven switches itself off.
3. The signal and the programme can be stopped by pressing any button.

## End time

1. Press the Mode  button repeatedly until the function indicator End time  flashes.
2. Using the increase  or decrease  button set the desired switch-off time.  
After approx. 5 seconds the display returns to showing the current time. The function indicator End time  lights up.  
When the time has elapsed, the function indicator flashes, an audible signal sounds for 2 minutes and the oven switches itself off.
3. The signal and the programme can be stopped by pressing any button.

### 1 tray, e.g. oven level 3

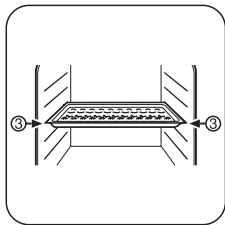

### 1 cake in cake tin, e.g. oven level 1

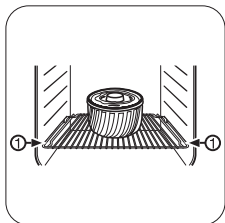

### 2 tray, e.g. oven levels 1 and 3

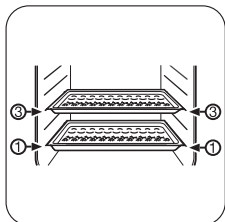

### Baking tins

- Baking tins made from dark-coloured metal with Teflon coating are suitable for baking using Conventional Cooking.
- For baking using the Fan Cooking function, baking tins made of shiny light-coloured metal are suitable.

### General instructions

- Insert the tray with the bevel at the front.
- When baking using Conventional Cooking and Fan Cooking, you can also place two baking trays next to one another on one level. This does not significantly affect the baking time.

**i** When frozen items are placed on baking trays, they can buckle during cooking. This happens due to the large difference in temperature between the frozen item and the oven. After cooling, the buckling in the trays disappears.

### How to use the Baking Tables

- The tables give the required temperature settings, cooking times and oven levels for a selection of typical dishes.
- Temperatures and baking times are for guidance only, as these will depend on the consistency of pastry, dough or mixture, the amount and the type of baking tin.
- We recommend setting the oven to a lower temperature for the first time and only setting a higher temperature when required, e.g. if you require more browning or if the baking is taking too long.
- If you cannot find the settings for a certain recipe, look for similar items.
- The baking time can be 10-15 minutes longer when baking cakes on trays or in tins on multiple levels.
- Recipes with moist ingredients such as pizzas or fruit flans are to be baked on one level.
- Cakes and pastries at different heights may brown at an uneven rate at first. You should not change the temperature setting if this occurs. Different rates of browning even out as baking progresses.
- Baking and roasting times could differ from those of your previous oven. For this reason you should adjust the settings you usually use (temperature, cooking times, etc.) and oven levels to the recommendations provided in the following tables.

### Roasting

#### Ovenware for roasting

- Any heat-resistant ovenware is suitable to use for roasting. (Please follow the manufacturer's instructions.)
- You can place large roasts **directly in the roasting tray or on the shelf with the roasting tray underneath.**
- We recommend roasting leaner cuts **in a roasting pan with a lid.** The meat will be more succulent.
- All types of meat which are supposed to be browned or form a crust or crackling can be roasted in a **roasting pan without a lid.**

**i** The information given in the following tables is for guidance only.

- We recommend meat and fish **weighing 1 kg or more** for roasting in the oven.



- To prevent escaping meat juices or fat from burning on to the pan, we recommend placing some liquid in the roasting cookware.
- If required, turn the roast after 1/2 - 2/3 of the cooking time.
- Use the cooking juices to baste large roasts and poultry several times during the cooking time. This will give better roasting results.

### Hints and tips when using the grill

- Most foods should be placed on the grid in the grill pan to allow maximum circulation of air and to lift the food out of the fats and juices.
- Adjust the grid and grill pan runner position to allow for different thicknesses of food.
- Position the food close to the element for faster cooking and further away for gentler cooking.
- Food should be thoroughly dried before grilling to minimise splashing. Brush lean meats and fish lightly with a little oil or melted butter to keep them moist during cooking.
- Accompaniments such as tomatoes and mushrooms may be placed underneath the grid when grilling meats.
- When toasting bread, use the shelf in the top position with the grid in the 'high' position.
- Preheat the grill on a full setting for a few minutes before sealing steaks or toasting. Adjust the heat setting and the shelf as necessary during cooking.
- The food should be turned over during cooking as required.
- When using the centre section grill, ensure food is placed centrally on the grilling grid directly beneath the grill element.

### Hints and tips when using the top oven

- Arrange the shelves in the required positions before switching the oven ON. Shelf positions are counted from the bottom upwards.
- There should always be at least 2.5cm (1") between the top of the food and the element. This gives best cooking results and allows room for rise in yeast mixtures, Yorkshire puddings etc. When cooking cakes, pastry, scones bread etc., place the tins or baking trays centrally on the shelf.
- Ensure that food is placed centrally on the shelf and there is sufficient room around the baking tray/dish to allow for maximum circulation.

- Stand dishes on a suitably sized baking tray on the shelf to prevent spillage onto the oven base and to help reduce cleaning.
- The material and finish of the baking tray and dishes used affect base browning. Enamelware, dark, heavy or non-stick utensils increase base browning. Shiny aluminium or polished steel trays reflect the heat away and give less base browning.
- Because of the smaller cooking space and lower temperatures, shorter cooking times are sometimes required. Be guided by the recommendations given in the cooking chart.
- For economy leave the door open for the shortest possible time, particularly when placing food into a pre-heated oven.

### Hints and tips when using fan cooking

- Arrange the shelves in the required positions before switching the oven on. Shelf positions are counted from the bottom upwards.
- When cooking more than one dish in the fan oven, place dishes centrally on different shelves rather than placing several dishes on one shelf, this will allow the heat to circulate freely for the best cooking results.
- When batch baking one type of food, e.g. Victoria sandwich cakes, those of similar size will be cooked in the same time.
- It is recommended that when baking larger quantities the shelf positions should be evenly spaced to suit the load being cooked. A slight increase in cooking time may be necessary.
- Do not place baking trays directly on the oven base as it interferes with the oven air circulation and can lead to base burning; use the lower shelf position.

### Hints and tips when defrosting

- Place the frozen food in a single layer where possible and turn it over half way through the defrosting process.
- The actual speed of defrosting is influenced by room temperature. On warm days defrosting will be faster than on cooler days.
- It is preferable to thaw fish, meat and poultry slowly in the fridge. However, this process can be accelerated by using the defrost function. Small or thin fish fillets, frozen peeled prawns, cubed or minced meat, liver, thin chops, steaks etc., can be thawed in 1 – 2 hours.

- A 1kg/2¼lb oven ready chicken will be thawed in approximately 5 hours. Remove the giblets as soon as possible during the thawing process.
- Joints of meat up to 2kg/4½lb in weight can be thawed using the defrost function.
- All joints of meat and poultry must be thawed thoroughly before cooking.
- Always cook thoroughly immediately after thawing.

- Do not leave food at room temperature once it is defrosted. Cook raw food immediately or store cooked food in the fridge, once it has cooled.

### Top Oven - Conventional Cooking

- i** Shelf Positions are not critical but ensure that oven shelves are evenly spaced when more than one is used (e.g. shelf positions 1 and 3)

Food	Temperature [°C]	Approx Cook Time (mins)	Shelf Position
Biscuits	170 - 190	10 - 20	1
Bread	200 - 220	30 - 35	1
Bread rolls/buns	200 - 220	10 - 15	1
Cakes:			
- Small & Queen	170 - 180	18 - 25	1
- Sponges	160 - 175	20 - 30	1
- Victoria Sandwich	160 - 170	18 - 25	1
- Madeira	140 - 150	75 - 90	1
- Rich Fruit	140 - 150	120 - 150	1
- Gingerbread	140 - 150	75 - 90	1
- Meringues	90 - 100	150 - 180	1
- Flapjack	160 - 170	25 - 30	1
- Shortbread	130 - 150	45 - 65	1
Casseroles:			
- Beef/Lamb	150 - 170	150 - 180	1
- Chicken	160 - 180	75 - 90	1
Convenience Foods	Follow manufacturer's instructions.		
Fish	170 - 190	20 - 30	1
Fish Pie (Potato Topped)	190 - 200	20 - 30	1
Fruit Pies, Crumbles	190 - 200	30 - 50	1
Milk Puddings	150 - 170	90 - 120	1
Pasta Lasagne etc.	170 - 180	40 - 50	1
Pastry:			
- Choux	180 - 190	30 - 40	1
- Eclairs, Profiteroles	180 - 190	30 - 40	1
- Flaky/Puff Pies	210 - 220	30 - 40	1

Food	Temperature [°C]	Approx Cook Time (mins)	Shelf Position
Shortcrust:			
- Mince Pies	190 - 200	15 - 20	1
- Meat Pies	190 - 210	25 - 35	1
- Quiche, Tarts, Flans	180 - 200	25 - 50	1
Scones	220 - 230	8 - 12	1
Shepard´s Pie	190 - 200	30 - 40	1
Soufflés	180 - 190	20 - 30	1
Vegetables:			
- Baked Jacket Potatoes	180 - 190	60 - 90	1
- Roast Potatoes	180 - 190	60- 90	1
Yorkshire Pudding:			
- Large	200 - 210	25 - 40	1
- Individual	210 - 220	15 - 25	1
Roasting Meat, Poultry	See roasting chart.		

## Top Oven - Grilling

 Adjust shelf position and grill pan grid to suit different thicknesses of food

Food	Grill Time (mins in total)
Bacon Rashers	5- 6
Beefburgers	10 - 20
Chicken Joints	20 - 40
Chops	
- Lamb	15 - 25
- Pork	20 - 25
Fish - Whole Trout/ Makarel	
	10 -12
Filletts - Plaice/Cod	4 - 6
Kebabs	12 - 18
Kidneys - Lamb/Pig	6 - 10
Sausages	20 - 30
Steaks	

Food	Grill Time (mins in total)
- Rare	4 - 6
- Medium	6 - 8
- Well Done	12 - 15
Toasted Sandwiches	3 - 4

## Main Oven - Thermaflow® - Baking

**i** Shelf Positions are not critical but ensure that oven shelves are evenly spaced when more than one is used (e.g. shelf positions 1 and 3)

Food	Temperature [°C]	Approx Cook Time (mins)
Biscuits	180 - 190	10 - 20
Bread	190 - 210	30 - 35
Cakes:		
- Small & Queen	160 - 170	18 - 25
- Sponges	160 - 170	20 - 25
- Madeira	140 - 160	60 - 75
- Rich Fruit	130 - 140	120 - 150
- Christmas	130 - 140	180 - 270
Fish	160 - 180	20 - 30
Fruit Pies, Crumbles	170 - 180	30 - 50
Milk Puddings	140 - 160	60 - 90
Pastry:		
- Choux	180 - 190	30 - 40
- Shortcrust	180 - 190	25 - 35
- Flaky	180 - 190	30 - 40
- Puff	Follow manufacturer's instructions; Reduce the temperature for Fan oven by 20°C	
Plate Tarts	180 - 190	25 - 45
Quiches/Flans	170 - 180	25 - 45
Scones	210 - 230	8 - 12
Roasting: Meat and Poultry	160 - 180	see Roasting Chart

## Main Oven - Thermaflow® - Roasting

Meat	Temperature [°C]	Cooking Time
Beef/ Beef boned	160 - 180	20-35 minutes per ½ kg (1lb) and 20-35 minutes over
Mutton/ Lamb	160 - 180	20-35 minutes per ½ kg (1lb) and 20-35 minutes over
Pork/ Veal/ Ham	160 - 180	30-40 minutes per ½ kg (1lb) and 30-40 minutes over
Chicken	160 - 180	15-20 minutes per ½ kg (1lb) and 20 minutes over
Turkey/ Goose	160 - 180	15-20 minutes per ½ kg (1lb) and 20 minutes over
Duck	160 - 180	25-35 minutes per ½ kg (1lb) and 25-30 minutes over
Pheasant	160 - 180	35-40 minutes per ½ kg (1lb) and 35-40 minutes over
Rabbit	160 - 180	20 minutes per ½ kg (1lb) and 20 minutes over

## Care and cleaning

 **Warning!** When cleaning, the appliance must be switched off and cooled down.

 **Warning!** Cleaning the appliance with a steam jet or high-pressure cleaner is prohibited for safety reasons.

 **Caution!** Do not use scourers, sharp tools or rinsing devices to clean the appliance.

Do not use scourers or metal scrapers to clean the glass oven door, as these could scratch the surface. This could cause the glass to shatter.

### The outside of the appliance

- Wipe the front of the appliance with a soft cloth and a solution of warm water and washing-up liquid.
- For metal surfaces use standard commercial cleaning products.
- Please do not use any scouring agents or abrasive sponges.

Clean the oven after every use. This is the easiest way to remove dirt which then cannot burn on.

### Inside of the oven

1. When the oven door is opened, the oven light bulb automatically illuminates.
2. Wipe out the oven after every use with a solution of washing-up liquid and then dry it.

 Remove stubborn dirt with special oven cleaners.

**Important!** When using oven sprays, please follow the manufacturer's instructions exactly. Make sure that no visible remaining detergents are left after the cleaning with oven spray!

### Accessories

- Clean and dry the oven accessories (shelf, tray, roasting pan, etc.) after each use. Soak the items to make cleaning easier.

### Side rails

The side rails on the right and left-hand side of the oven interior can be removed for the purpose of cleaning the side walls.

## Removing the side rails

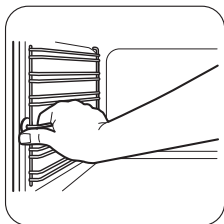

Pull the rails away from the oven wall at the front

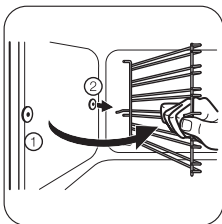

Unhook them at the back

## Replace the side rails

**Important!** Important The rounded ends of the guide bars must point to the front.

To install, first (1) and then .

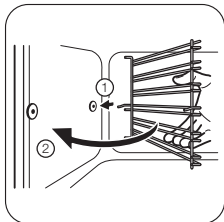

Insert the rails in the holes at the back

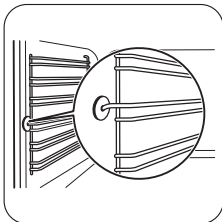

Lower into position at the front and press them at the back

## Oven back lamp (for selected models only)

**!** **Warning!** Risk of electric shock! Before replacing the oven light bulb:

- Switch oven off.
- Unscrew the fuse from the fuse box or switch fuse off.

**i** To protect the oven light bulb and the glass cover, lay a cloth on the floor of the oven.

## Replacing the oven light bulb/Cleaning the glass cover

1. Take off the glass cover by turning it anticlockwise and clean it.

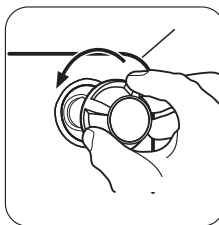

2. If necessary: replace with a **40 Watt, 230V, 300°C heat-resistant oven light bulb** .

3. Refit the glass cover.

## Replacing the side oven lamp/Cleaning the glass cover (for selected models only)

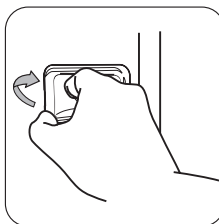

1. Take out the left-hand side rails.
2. Remove the glass cover with the help of a small, blunt object (e.g. a teaspoon) and clean it.
3. If necessary: replace halogen oven light bulb. Order the replacement light bulb from the Customer Care Department (see section "Service/Customer Care Department").

**i** Always touch the halogen light bulb using a cloth to avoid grease contamination.

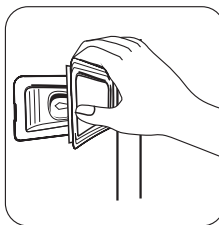

4. Refit the glass cover.
5. Replace the side rails.

## Oven door glass

The oven door comprises 2,3 or 4 panels of glass (depends of the model) mounted one on top of another. The interior glass panels can be removed for cleaning.

**Important!** Important: Rough handling, especially around the edges of the front panel, can cause the glass to break.

### Removing the glass door panels

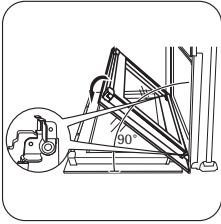

Open the door as far as it will go.

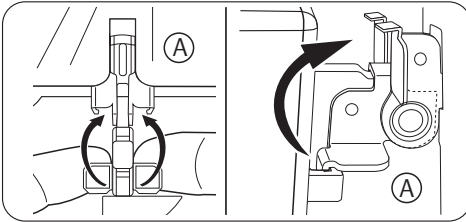

Loosen the **clamp levers** on both door hinges (A) **completely**.

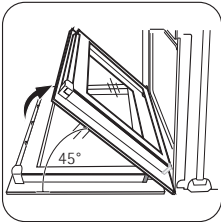

Close the oven door to the first open position (approx. 45°).

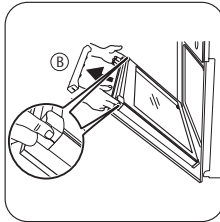

Hold the door strip (B) on the upper side of the oven door on both sides and press this inwards in order to loosen the seal. Then pull the door strip upwards and off.

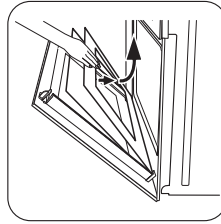

Hold the glass panels on their upper side and one after the other pull them up and out of their retainers.

### Cleaning the glass door panels

Thoroughly clean the glass door panels using a solution of water and washing-up liquid. Then dry them carefully.

### Replacing the glass door panels

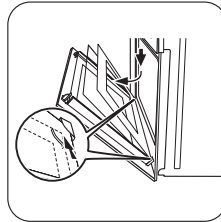

Slide the glass door panels one after the other into the retainers from above at an angle and then lower the panels.

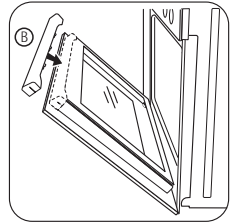

Hold the door strip (B) on both sides, align it with the inner edge of the door and press the door strip (B) into the upper edge of the door.

**i** The two smaller panels should be inserted first, then the larger panel.

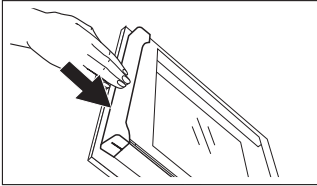
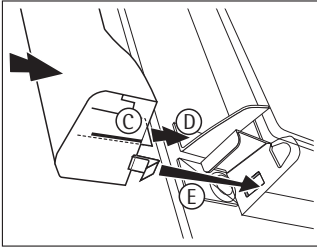

On the open side of the door strip (B) there is a guide bar (C). This must be pressed between the outer side of the door and the corner (D). The seal (E) must audibly click into place.

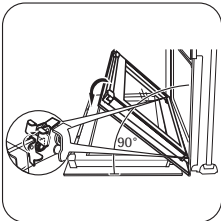

Open the door as far as it will go.

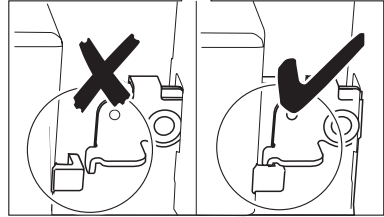
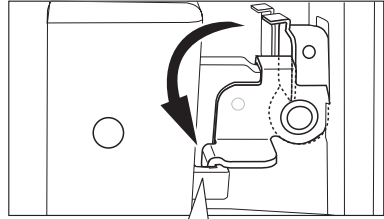

Fold the clamp levers on both door hinges (A) down into their original position.  
Close the oven door.

**! Warning!** Before cleaning always allow the appliance to cool down before switching off at the electricity supply.

### Cleaning materials

Before using any cleaning materials on your appliance, check that they are suitable and that their use is recommended by the manufacturer. Cleaners that contain bleach should not be used as they may dull the surface finishes. Harsh abrasives and scourers should also be avoided.

### Cleaning the outside of the appliance

Do not use abrasive cleaning materials e.g. abrasive cream cleaners, wire wool pads or scourers on painted or printed finishes as damage may occur. Regularly wipe over the control panel, control knobs, handles, doors and appliance sides using a soft cloth and hot soapy water. To prevent streaking, finish with a soft cloth.

Stainless Steel cream cleaners are abrasive and should be avoided as they may dull the surface finish. **Any spillage on the stainless steel finish must be wiped off immediately.**

**! Warning!** Do not attempt to remove any of the control knobs from the appliance as this may cause damage and is a safety hazard.



## Cleaning inside the grill and oven compartments

The vitreous enamel coating in the grill/top oven and main oven compartments can be cleaned using normal oven cleaners with care.

Ensure that the manufacturers instructions are followed and that all parts are well rinsed afterwards.

 **Warning!** Aerosol cleaners must not come into contact with elements, the door seal, or any painted finishes as this may cause damage.

### Cleaning the door(s)

 **Warning!** Under no circumstances should the door assembly be detached from the product for cleaning.

 **Warning!** To prevent damaging or weakening the door glass panels avoid the use of the following:

- Household detergents and bleaches.
- Soap Impregnated pads unsuitable for non-stick saucepans.
- Abrasive cleaning pads, scorers and steel wool pads.
- Chemical oven pads or aerosols.
- Rust removers.
- Bath/Sink stain removers.

### Cleaning between the outer and inner door glass

The door glass is removable for cleaning.

Clean the outer and inner glass using hot soapy water or hob cleaner may be used. Do not use hob cleaner on the Stainless Steel or painted finishes.

Ensure that all parts are well rinsed and thoroughly dried before attempting to replace the outer door.

## What to do if...

 **Warning!** Repairs to the appliance must only be carried out by qualified service engineers. Considerable danger to the user may result from improper repairs.

 In the case of misuse the visit by the Customer Care Department technician or the repair may be chargeable, even during the warranty period.

 Information for appliances with metal fronts:  
Due to the appliance's cool front, when the door is opened during or shortly after baking or roasting, there

may be condensation of the inner glass panel for a short while.

Please carry out the following checks on your appliance before calling a Service Engineer. It may be that the problem is a simple one which you can solve yourself without the expense of a service call.

**In-guarantee customers should make sure that the checks have been made as the engineer will make a charge if the fault is not a mechanical or electrical breakdown.**

Please note that proof of purchase is required for in-guarantee service calls.

Problem	Possible Solution
The grill, ovens and timer do not work.	Check that the appliance has been wired in to the appliance supply and is switched on at the wall. Check that the main appliance fuse is working. If you have checked the above: Allow the appliance to cool for a couple of hours. The appliance should now be working normally.
The grill does not work or cuts out after being used for a long period of time.	Ensure the cooling fan is running when the grill is on. If the cooling fan fails, the grill will not operate correctly. Contact your local service force centre. Leave the grill door open and allow the grill to cool. After a couple of hours check that the grill works as normal
The indicator neons are not working correctly.	Check that you have selected only the function you require. Ensure all other controls are in the off position.

Problem	Possible Solution
The oven is not cooking evenly.	Check that the appliance is correctly installed and is level.
	Check that the recommended temperatures and shelf positions are being used.
The oven light fails to illuminate.	The oven light bulb may need replacing.
The oven fan is noisy.	Check that the oven is level.
	Check that the shelves and bakeware are not vibrating in contact with the oven back panel.
The oven temperature is too high or too low.	Check that the recommended temperatures and shelf positions are being used. Be prepared to adjust the temperature up or down slightly to achieve the results you want.

## Installation

- The set-up of the electrical installation is arranged so that the appliance can be isolated from the mains with a minimum 3 mm all-pole contact separation. Suitable isolation devices include, for example, circuit breakers, fuses (screw type fuses are to be removed from the holder), RCDs and contactors.
- Anti-shock protection must be provided by the installation.
- The built-in unit must meet the stability requirements of DIN 68930.
- Built-in cookers and cooking surfaces are equipped with special attachment systems. For safety reasons, they must only be combined with appliances from the same manufacturer.

The use of heat protection strips is prohibited for cookers and ovens with Pyrolytic Cleaning, if the recess has a rear wall and closed ground-level compartment. However installation is possible with a ground-level compartment that has been shortened by at least 20 mm and which has base ventilation of the same cross-section.

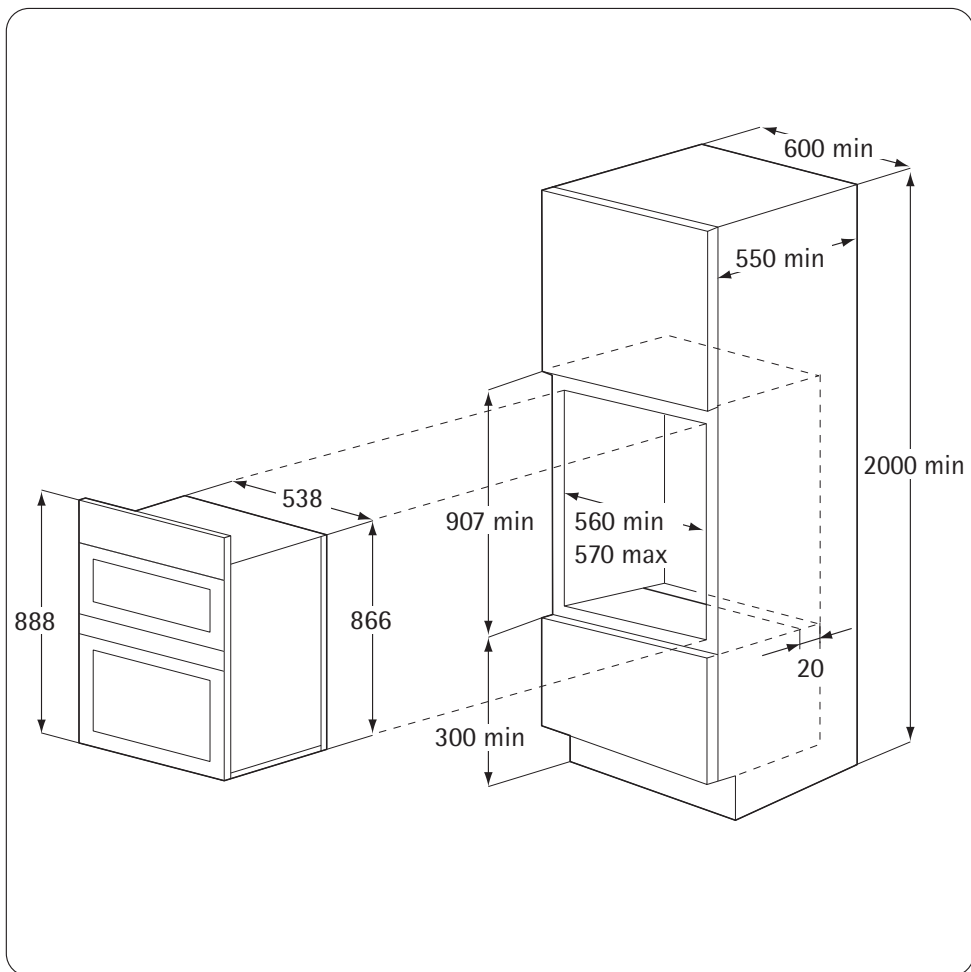

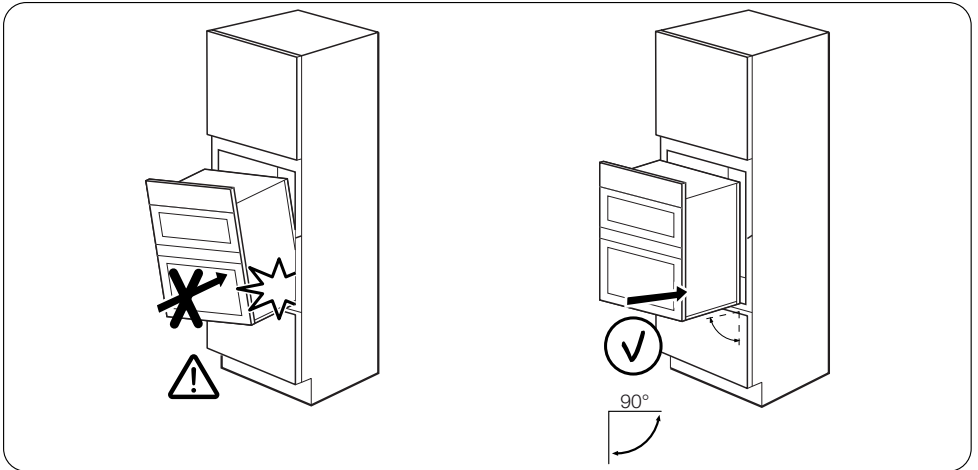
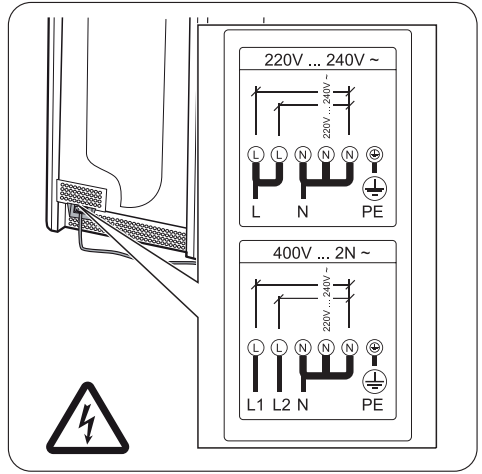
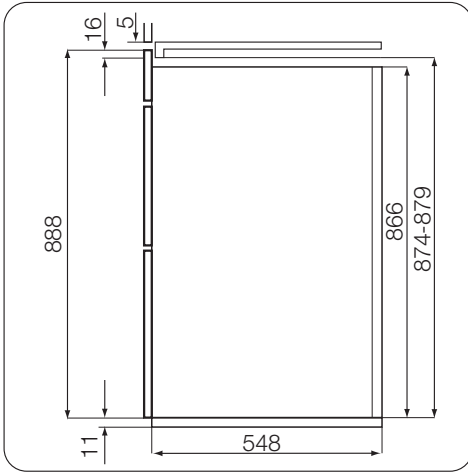

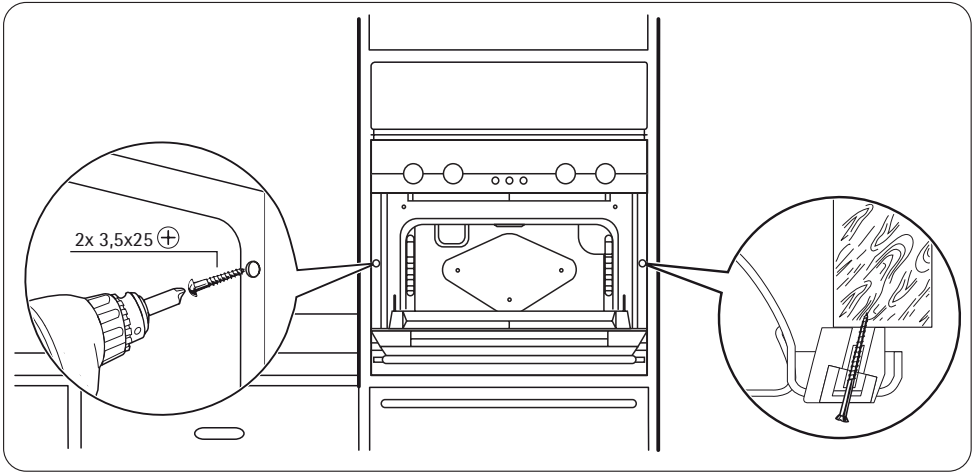

## Electrical Installation

- Enquiries regarding the installation of the cooker point, if required, should be made to your Regional Electricity Company to ensure compliance with their regulations.
- The appliance socket switch should be outside the cabinet but within 2m of the appliance to make it accessible to switch off the appliance in case of an emergency.
- To protect the hands, wear gloves when lifting the oven into its housing.

### Important! HOUSE CIRCUIT

Earth leakage and continuity tests must be carried out before the appliance is connected to the mains supply and re-checked after fitting.

### GETTING THINGS READY CHOICE OF ELECTRICAL CONNECTION

There are three possible ways to connect your appliance. In each case the appliance should be operated using at least 6mm<sup>2</sup> twin core and earth PVC insulated multicore cable. Please choose from the most appropriate after reading the different methods :

- By connecting to a cooker point (having a double pole isolating switch with at least 3mm contact separation in all poles and neutral) and protected with a fuse or miniature circuit breaker at your mains fuse box.
- By connecting the appliance together with a hob directly to a cooker point(s). Having a double pole iso-

lating switch with at least 3mm contact separation in all poles and neutral.

- If you wish to connect an oven and a hob to a cooker point you can by connecting the oven and hob separately to the cooker point. Oven and hob units should be separately connected to a cooker point. (See Picture)

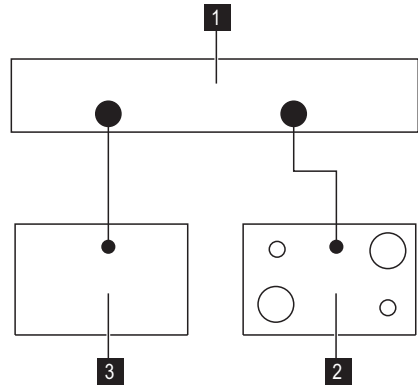

**1** Cooker Point

**2** Hob

**3** Oven

It is good practice to :

- Fit an Earth Leakage Circuit Breaker to your house wiring.
- Wire your appliance to the latest IEE regulations.

## Disposal

The symbol  on the product or on its packaging indicates that this product may not be treated as household waste. Instead it should be taken to the appropriate collection point for the recycling of electrical and electronic equipment. By ensuring this product is disposed of correctly, you will help prevent potential negative consequences for the environment and human health, which could otherwise be caused by inappropriate waste handling of this product. For more detailed information about recycling of this product, please contact your local council, your household waste disposal service or the shop where you purchased the product.



### Packaging material

The packaging material is environmentally-friendly and recyclable. Plastic parts are marked with the international abbreviations such as, e.g. >PE<, >PS< etc. Dispose of the packaging material in the containers provided for this purpose at your local waste management facility.



**Warning!** Your appliance should be made inoperable before it is disposed of, so that it does not constitute a danger.

To do this, take the mains plug from the socket and remove the mains cable from the appliance.

## GREAT BRITAIN & IRELAND - Guarantee/Customer Service

### Standard guarantee conditions

We, Electrolux, undertake that if within 12 months of the date of the purchase this Electrolux appliance or any part thereof is proved to be defective by reason only of faulty workmanship or materials, we will, at our option repair or replace the same FREE OF CHARGE for labour, materials or carriage on condition that:

- Appliance has been correctly installed and used only on the electricity supply stated on the rating plate.
- Appliance has been used for normal domestic purposes only, in accordance with manufacturer's instructions.
- Appliance hasn't been serviced, maintained, repaired, taken apart or tampered with by person not authorised by us.
- Electrolux Service Force Centre must undertake all service work under this guarantee
- Any appliance or defective part replaced shall become the Company's property.
- This guarantee is in addition to your statutory and other legal rights.

### Exclusions

- Damage, calls resulting from transport, improper use, neglect, light bulbs, removable parts of glass, plastic.
- Costs for calls to put right appliance which is improperly installed, calls to appliances outside United Kingdom.

- Appliances found to be in use within a commercial environment, plus those which are subject to rental agreements.
- Products of Electrolux manufacturer that are not marketed by Electrolux

**Service and Spare Parts.** Please contact your local Service Force Centre: **0870 5 929 929** (Call will be routed to Service Force Centre covering your postcode area).

For address of local Service Force Centre and further information, please visit: [www.serviceforce.co.uk](http://www.serviceforce.co.uk)

Before calling out an engineer, please ensure you have read the details under the heading "What to do if..."

When you contact the Service Force Centre you will need to give the following details:

Your name, address and postcode, your telephone number, clear concise details of the fault, model and serial number of the appliance (found on the rating plate), the purchase date.

Please note a valid purchase receipt or guarantee documentation is required for in guarantee service calls.

**Customer Care.** Please contact our Customer Care Department: Electrolux Major Appliances, Addington Way, Luton, Bedfordshire, LU4 9QQ or visit our website at [www.electrolux.co.uk](http://www.electrolux.co.uk) Customer Care Department,

	Tel: (Calls may be recorded for training purposes)
Electrolux	08705 950 950
AEG-Electrolux	08705 350 350
Zanussi-Electrolux	08705 727 727

**For Customer Service in The Republic of Ireland please contact us at the address below:**

Electrolux Group (Irl) Ltd, Long Mile Road, Dublin 12, Republic of Ireland  
Tel: +353 (0)1 4090751, Email: service.eid@electrolux.ie

[www.electrolux.com](http://www.electrolux.com)

		
Albania	+35 5 4 261 450	Rr. Pjeter Bogdani Nr. 7 Tirane
Belgique/België/Belgien	+32 2 363 04 44	Bergensesteenweg 719, 1502 Lembeek
Česká republika	+420 261302111	Budějovická 3, Praha 4, 140 21
Danmark	+45 70 11 74 00	Sjællandsgade 2, 7000 Fredericia
Deutschland	+49 180 32 26 622	Fürther Str. 246, 90429 Nürnberg
Eesti	+37 2 66 50 030	Pärnu mnt. 153, 11624 Tallinn
España	+34 902 11 63 88	Carretera M-300, Km. 29,900 Alcalá de Henares Madrid
France	08 44 62 26 53	<a href="http://www.electrolux.fr">www.electrolux.fr</a>
Great Britain	+44 8705 929 929	Addington Way, Luton, Bedfordshire LU4 9QQ
Hellas	+30 23 10 56 19 70	4, Limnou Str., 54627 Thessaloniki
Hrvatska	+385 1 63 23 338	Slavonska avenija 3, 10000 Zagreb
Ireland	+353 1 40 90 753	Long Mile Road Dublin 12
Italia	+39 (0) 434 558500	C.so Lino Zanussi, 26 - 33080 Porcia (PN)
Latvija	+371 67313626	Kr. Barona iela 130/2, LV-1012, Riga
Lietuva	+370 5 278 06 03	Ozo 10a, LT-08200 Vilnius
Luxembourg	+352 42 431 301	Rue de Bitbourg, 7, L-1273 Hamm
Magyarország	+36 1 252 1773	H-1142 Budapest XIV, Erzsébet királyné útja 87

		
Nederland	+31 17 24 68 300	Vennootsweg 1, 2404 CG - Alphen aan den Rijn
Norge	+47 81 5 30 222	Risløkkvn. 2 , 0508 Oslo
Österreich	+43 18 66 400	Herziggasse 9, 1230 Wien
<b>Polska</b>	<b>+48 22 43 47 300</b>	<b>ul. Kolejowa 5/7, Warszawa</b>
Portugal	+35 12 14 40 39 39	Quinta da Fonte - Edifício Gonçalves Zarco - Q 35 -2774-518 Paço de Arcos
<b>Romania</b>	<b>+40 21 451 20 30</b>	<b>Str. Garii Progresului 2, S4, 040671 RO</b>
Schweiz - Suisse - Svizzera	+41 62 88 99 111	Industriestrasse 10, CH-5506 Mägenwil
<b>Slovenija</b>	<b>+38 61 24 25 731</b>	<b>Gerbičeva ulica 98, 1000 Ljubljana</b>
Slovensko	+421 (02) 32141334	Electrolux Slovakia s.r.o., Electrolux Domáce spotrebiče SK, Seberíniho 1, 821 03 Bratislava
Suomi	www.electrolux.fi	
Sverige	+46 (0)771 76 76 76	Electrolux Service, S:t Göransgatan 143, S-105 45 Stockholm
Türkiye	+90 21 22 93 10 25	Tarlabası caddesi no : 35 Taksim İstanbul
Россия	+7 495 937 7837	129090 Москва, Олимпийский проспект, 16, БЦ "Олимпик"
Україна	+380 44 586 20 60	04074 Київ, вул.Автозаводська, 2а, БЦ "Алкон"









[www.zanussi-electrolux.co.uk](http://www.zanussi-electrolux.co.uk)

892930013-F-082009

[www.zanussi.com](http://www.zanussi.com)

